

**TOP 5**

# Chemical Applications

**Optek**<sup>®</sup>  
inline control

**english**  
deutsch  
español  
portuguese  
русский язык  
中国  
日本語  
français  
italiano



**optek can measure:**

- Acetone
- Alcohol, Water in
- Activated Carbon
- Aldehyde
- Aniline
- APHA
- Aromatics
- ASTM
- Benzene
- Benzaldehyde
- Benzyl Chloride
- BTEX
- Bisphenol A
- Bromine
- Chemical Nickel
- Chlorine
- Chlorobenzene
- Chlorine Dioxide
- Chlorophyll
- Chromat
- Cobalt
- COD
- Color
- Copper
- Cresol
- Dichromate
- Fluorine
- Gardner®
- Hazen
- Hydrogen Peroxide
- Hypochlorite
- Iodine
- Iron
- Ketones
- Lime Water
- MDI/MDA
- Naphtalene
- Nickel
- Nitrobenzene
- NOX
- Oil in Water
- Ozone
- Peracetic Acid
- Permanganate
- Phenol
- Phthalic Acid
- Pyridine
- Sulfur Dioxide
- Styrene
- Suspensions
- TDA
- Toluene
- TOC (SAK 254)
- Turbidity
- UV-Absorption
- Water Concentration
- Water in Oil
- Water in Fuel
- Xylene

and many more...

**TOP 1 Halogen Concentration**

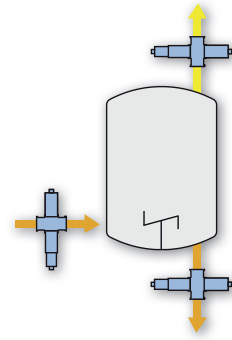

**TOP 2 Filter Control**

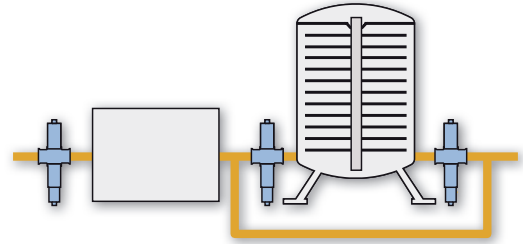

**TOP 3 Color and Concentration**

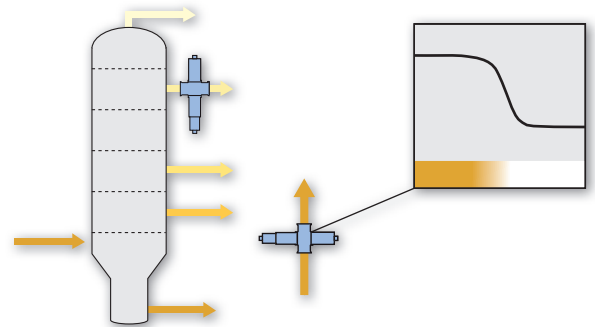

**TOP 4 Leak Detection / Condensate / Carryover Monitoring**

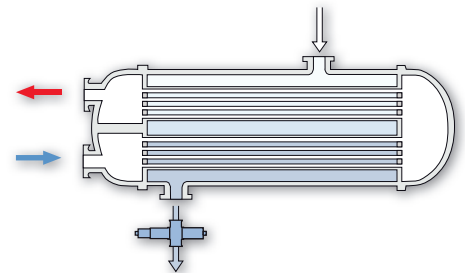

**TOP 5 Interface Detection**

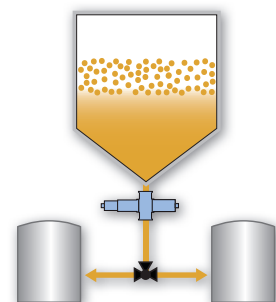

For over 30 years, optek has focused on measuring process liquids through their interaction with light in facilities all over the world. Although global, optek remains a family owned company with a team of more than 100 qualified, customer-driven professionals.

Our confidence is born from experience. With the expertise of more than 30,000 installations worldwide, our value to the customer resides in providing a superior product that pays back. High quality materials withstand the toughest process conditions including aggressive media, high temperature, and

high pressure applications. Cleanability is ensured using high quality wetted materials, superior design, as well as sapphire optical windows.

As a global partner to various industries, optek offers the most advanced technologies including superior signal amplification, inline calibration support, PROFIBUS® PA, FOUNDATION™ Fieldbus and multilingual user interfaces for easy onsite operations.

Our support ensures long term satisfaction with programs such as “Speed-Parts” and “SwapRepair” to provide our

customers sustainable operations and minimized downtime at the lowest cost of ownership.

Conformity to international (ISO 9001), industry-specific (FM/ATEX approval) or company standards is easily achieved with optek. Wherever process composition is controlled, the name optek has become synonymous with world-class products and support.

**Optimize your process with optek inline control.**



## Content

### **TOP 5** Chemical Applications

<b>TOP 1</b>	Halogen Concentration	04
<b>TOP 2</b>	Filter Control	06
<b>TOP 3</b>	Color and Concentration	08
<b>TOP 4</b>	Leak Detection / Condensate / Carryover Monitoring	10
<b>TOP 5</b>	Interface Detection	12
Principles of Measurement		14
Additional Benefits		15
Contact		16

**See our various product and application brochures for further details**

## 04 | Halogen Concentration



optek C4000 Photometric Converter

optek provides high performance inline photometric process analyzers to the chemical industry. Installed at strategic points within the process (inlet pipes, outlet tubes, in tail gas of reactors or in waste water streams), these analyzers provide an excellent return on investment.

### Chlorine Concentration

Chlorine plays a significant part in the production of chemicals, pharmaceuticals, disinfectants, bleaching agents and insecticides. optek process analyzers provide reliable and repeatable chlorine measurements inline. These chlorine concentration measurements are performed in real-time without the need for hazardous sampling.

Measurements are possible in low and high percent ranges for gaseous phase processes and ppm levels for liquid phase processes. Available options include high pressure, high temperature, ATEX and FM hazardous area classifications.

Measurements of other halogens like fluorine, bromine and iodine can also be achieved in gaseous and liquid phases.

### Measurement

Using a secondary wavelength, optek dual channel sensors compensate for background turbidity or other media constituents automatically. The signals from other instruments measuring temperature or pressure are recommended to be used directly as compensation for the raw gaseous halogen concentration. The optek C4000 converter processes up to two mA-inputs, displaying the compensated signal and transmitting it via four mA-outputs or with PROFIBUS® PA or FOUNDATION™ Fieldbus.

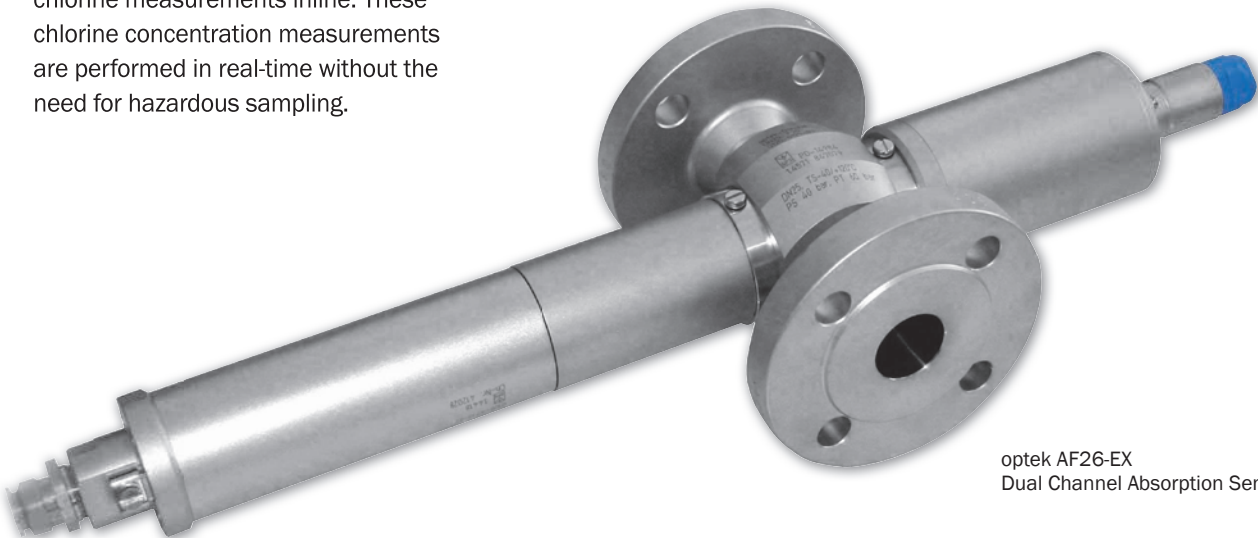

optek AF26-EX  
Dual Channel Absorption Sensor

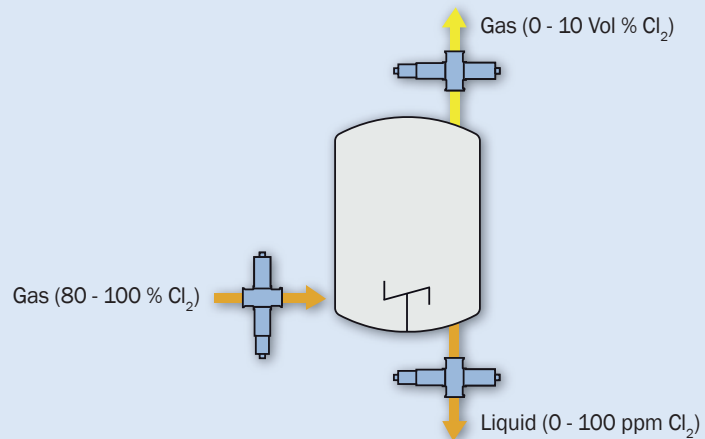

As shown in the above illustration, the chlorine is measured in the inlet of the reactor to determine the actual concentration. In the exhaust outlet, the chlorine concentration can be monitored in the gaseous phase for legal and environmental reasons and to prevent excess emissions to the atmosphere. A sensor installed in a bypass or outlet line determines the actual concentration of the chlorine in the liquid phase. Monitoring these three points ensures the highest process performance, minimizes product losses and reduces emissions.

Due to the very aggressive chemical medium, wetted parts of the analyzer are manufactured of corrosion resistant materials like titanium, TFM, sapphire windows and fluoroelastomer O-Rings. These materials are proven to withstand highly corrosive media like wet chlorine in numerous installations.

### Improve Efficiency

Using optek sensors in chemical plants provides real-time monitoring of halogens from high to low concentrations in gaseous and liquid phases.

The ability to monitor exhaust gases prevents pollution of the atmosphere while reducing the consumption and excess emissions of chlorine in chlorination reactions.

Controlling the feed rate to the reactor (chlorinator) in a dynamic control loop maximizes production efficiency and minimizes sample preparation costs.

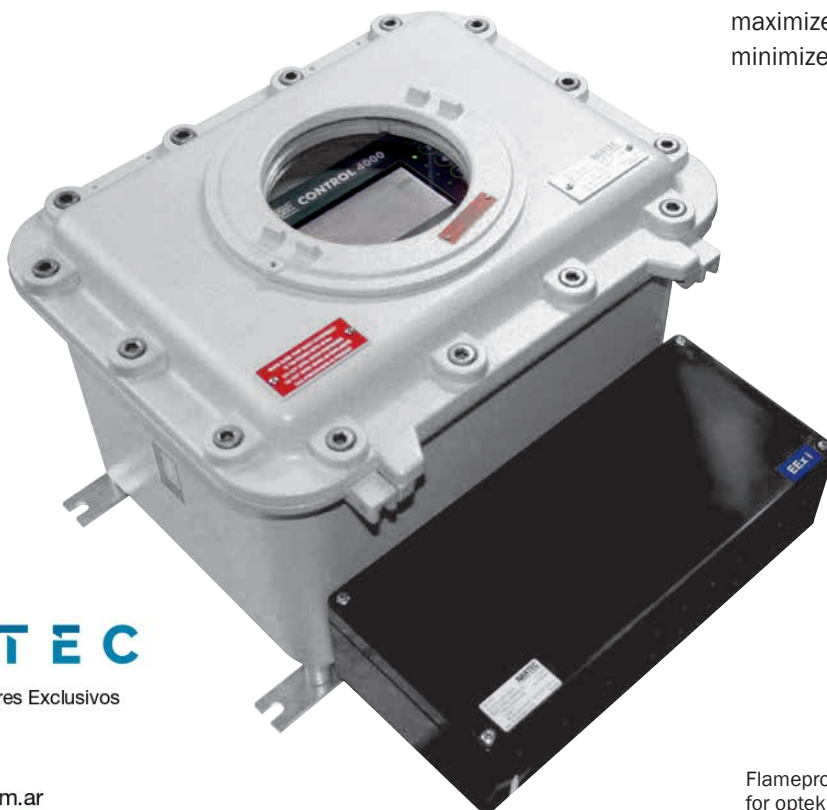

**DASTEC**

Representantes / Distribuidores Exclusivos

Argentina

Tel: (+54 11) 5352 2500

Email: [info@dastecsrl.com.ar](mailto:info@dastecsrl.com.ar)

Web: [www.dastecsrl.com.ar](http://www.dastecsrl.com.ar)

Uruguay [www.dastecsrl.com.uy](http://www.dastecsrl.com.uy)

Paraguay [www.dastecsrl.com.py](http://www.dastecsrl.com.py)

Flameproof Housing EX d  
for optek C4000 Converter



## 06 | Filter Control

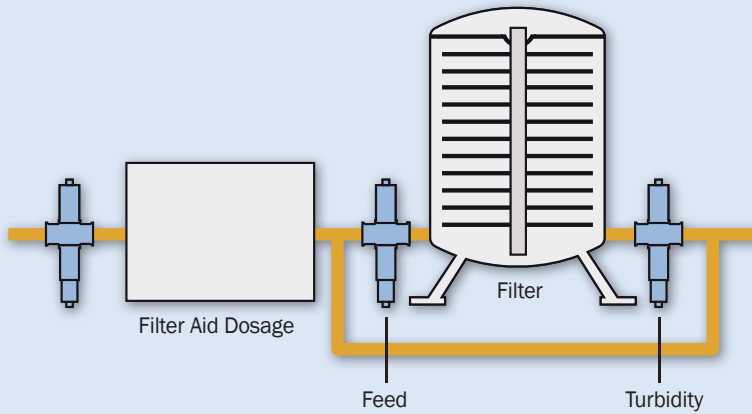

Many processes require filtration to clarify the product. Filtration proceeds from coarse filtration by means of separators, decanters, or settling tanks to a final polishing by diatomaceous earth (DE) or other precoat media filters.

To control product clarity, a turbidimeter can be installed at the start of the filtration process and in between each filtering step. If product turbidity reaches an unacceptable level, the flow can be automatically recirculated or switched to an alternate filter.

### Effective Filtration

optek photometers can monitor and control filter media dosing to ensure uniform precoat feed. This reduces filter media usage and extends the filter run by dosing only the amount of media necessary for effective filtration. Excessive amounts of filter media reduce the effective filtration time and increase product losses and process downtime.

The use of optek inline sensors greatly reduces the risk of equipment failure and operator error. This avoids costly refiltering, downtime and poor product quality. optek sensors ensure that proper clarity is achieved before transferring the product to the next process stage.

### Feed Stream

In addition to filtrate monitors, many large-scale processors implement an AF16-N NIR absorption sensor on the precoat side of the filter. This NIR turbidimeter measures total suspended solids in real-time allowing operators to control filter media dosing based on need rather than flow rate. Continuous monitoring of filter media addition allows accurate control of precoat concentration to ensure proper cake thickness and uniformity. This optimizes the use of filter media while extending filter runs. As the precoat media is deposited, filtrate clears up gradually. The moment the sensor detects the filtrate has achieved acceptable clarity, the converter signals the filter controller to switch from precoating to filtering operation.

The AF16-N sensor is also used to detect heavy solids carryover from storage tanks or prefiltration failure. Upon reaching the user defined high turbidity level, the filter can be switched to a recycle mode and incoming product is diverted to a settling tank, separator or to be refiltered. This will prevent filter blinding and provide extended use of the filter.

### Backwash Optimization

An inline sensor can also be used to optimize filter backwash process by measuring the turbidity in the water, saving time, energy and water usage.



optek C4000 Photometric Converter

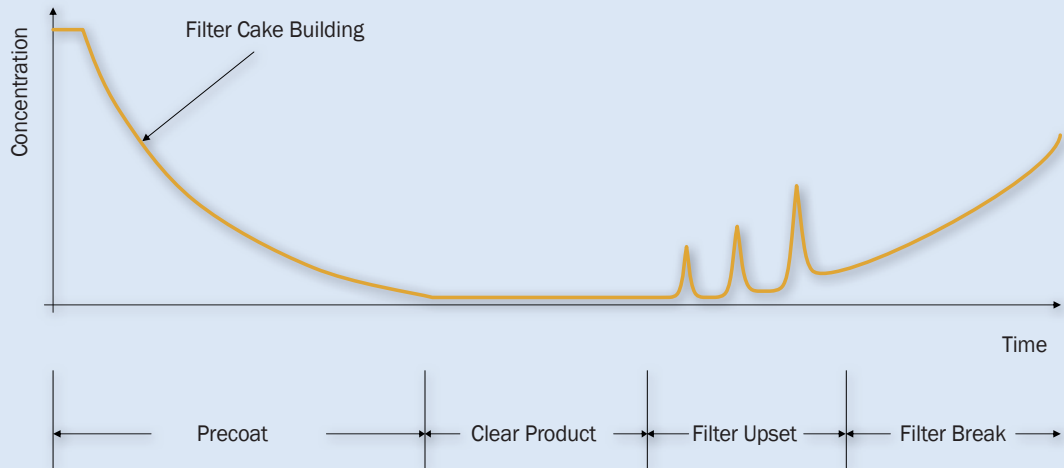

### Filtrate Stream

To ensure product quality, it is necessary to measure and control turbidity at the filter outlet. An optek TF16-N scattered light turbidimeter precisely monitors very low concentrations of suspended solids from 0 – 0.5 to 0 – 500 PPM or 0 – 0.2 to 0 – 200 FTU to achieve the desired clarity of the product.

Installing an inline turbidimeter on the filtrate stream allows for the automatic diversion of the filtrate to recirculate until the product clarity is improved to an acceptable level.

Installed directly inline, optek turbidimeters optimize filter performance and immediately detect filter upsets or breaks. These turbidimeters also greatly reduce or eliminate the amount of sampling and lab analysis performed for quality assurance.

### Quality Control

Proven to be a valuable tool for process control and quality assurance, optek turbidimeters ensure that product clarity is consistently maintained. Reducing product losses, increasing filtration capacity and optimizing filter media are only a few of the benefits optek inline sensors provide.

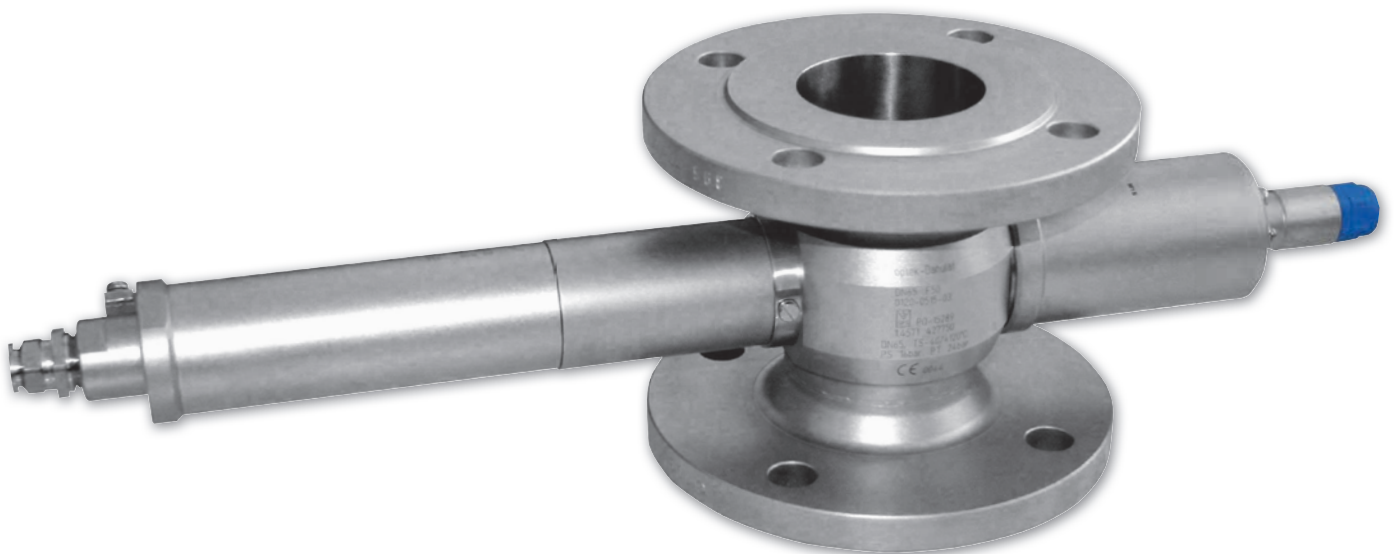

optek TF16-EX-N  
Scattered Light Dual Channel Turbidity Sensor

## 08 | Color and Concentration

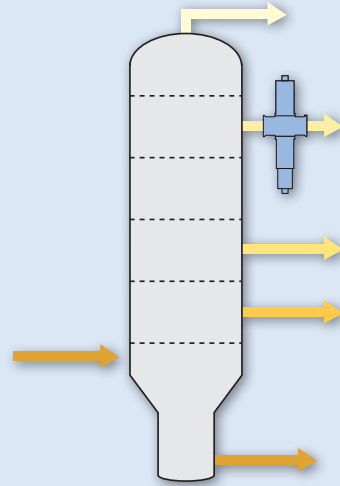

### Color Measurements

Color measurements of liquids are critical in maintaining precise process control and meeting product quality specifications.

Color changes indicate other process variables such as overheating, change in dilution ratios, the presence of dissolved impurities and finished product appearance. Typically, process color measurements are made by taking samples from the process piping and analyzing them in a lab either visually or using a laboratory analyzer. optek colorimeters provide precise, real-time color change detection directly in the pipeline.

Color measurements are achieved by passing focused light from the sensors lamp, through the process medium, to the sensors detector. As the light interacts with the process medium, some of it is absorbed, thus changing its intensity. The amount of light absorbed, which is wavelength and optical path length (OPL) dependent, will then be an indicator of color or color change.

Changes in light absorbance, due to changes in color, are monitored by the detector in the sensor and a signal is sent to the C4000 converter. The C4000 converter correlates the changes in absorbance to a color scale such as APHA/Hazen, ASTM, Saybolt or others and generates a signal to a PLC or DCS, using analog outputs, Profibus PA® or FOUNDATION™ Fieldbus. The C4000's local, real-time display allows operators immediate access to ongoing process parameters.

### Concentration Measurement

The measurement is represented in Concentration Units (CU) at a given wavelength with a defined optical path length (OPL) and relates to the concentration of the constituents in question that interact with the light.

### Process Optimization

The detection of impurities, reduction of product losses and the real-time assurance of product quality can be obtained by the use of inline colorimeters. In addition, these analyzers greatly reduce laboratory and production costs, eliminate human error and prevent environmental contamination.



**DASTEC**

Representantes / Distribuidores Exclusivos

Argentina

Tel: (+54 11) 5352 2500

Email: [info@dastecsrl.com.ar](mailto:info@dastecsrl.com.ar)

Web: [www.dastecsrl.com.ar](http://www.dastecsrl.com.ar)

Uruguay [www.dastecsrl.com.uy](http://www.dastecsrl.com.uy)

Paraguay [www.dastecsrl.com.py](http://www.dastecsrl.com.py)

optek AF26-EX-HT  
Dual Channel Absorption Sensor



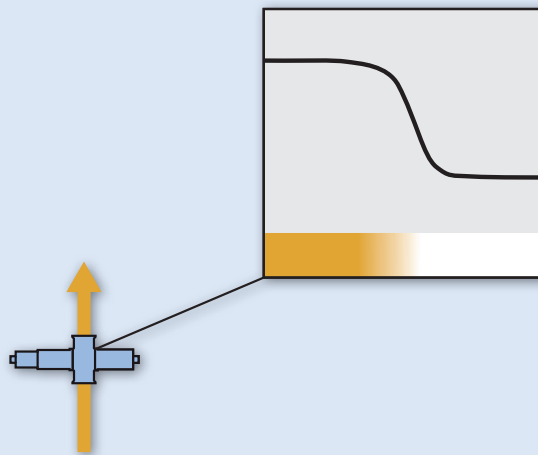

## Typical Applications

- Color scales (APHA / Hazen / Pt-Co, ASTM D-1500, Saybolt, Gardner® and other scales)
- Concentration of chlorine dioxide
- Transition metals (nickel, copper, chromium, iron, cobalt, manganese)
- Color dosing and decolorization control
- Leak detection/carryover
- Product interface and dosing/blending control
- Distillation control
- Quality control in solvents / epoxy resins (APHA / Hazen / Pt-Co, ppm iron)
- Concentration measurements of colored additives and catalysts (e.g., iron in HCl)
- Galvanic plating operations (nickel plating)
- Copper sulfate concentration in copper foil manufacturing
- Water/solvent ratio measurement
- Hypochlorite concentration

optek C4000 Photometric Converter



## C4000 Benefits

- Lifetime factory calibration for scattered light sensors
- Process control functions via Remote or PROFIBUS® PA / FOUNDATION™ Fieldbus
- Integrated data logger for quality control
- Secondary zero for additional offset and slope function
- User defined units (e.g., APHA, Hazen, Saybolt, Gardner®, ASTM, etc.)
- 7 menu languages selectable: German, English, French, Dutch, Spanish, Portuguese and Russian
- Flameproof housing available

# 10 | Leak Detection / Condensate / Carryover Monitoring

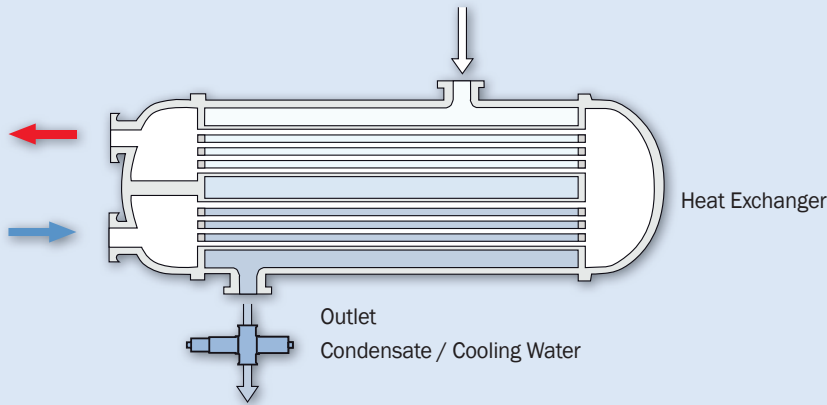

## Leak Detection

Leak detection is an important consideration for many chemical processing plants. Companies in all industries demand the measurement of leaked hydrocarbons, aromatics and chemicals in the ppm range, with each leaked medium requiring a different detection technique. optek's ability to customize solutions based on the application parameters provide the plant with a reliable, real-time monitoring system in almost any process condition.

## Heat Exchanger Monitoring

Heat exchanger monitoring is a very common application, where water is typically on the low pressure side and the leaking medium (e.g., hydrocarbons) is on the high pressure side. In the case where the leaking medium is immiscible in water, the water can be monitored by optek's TF16-N scattered light turbidity sensor, which can detect oils, amines, particles, hydrocarbons and even gas bubbles down to the single ppm range.

In the case where the leaking medium is miscible in water and results in some type of chemical contamination or a color change, the water can be monitored with an AF26 dual beam absorption sensor. The AF26 can detect virtually any impurities causing color change and can detect many chemicals down to the ppm range. If aromatics are the leaking medium, the

AF46 can monitor down to low ppm ranges. The AF46 is used where the light absorbing leaked medium has absorbance in the ultra violet (UV) range of the light spectrum.

The C4000 converter receives the signals from the sensors, correlates them to a concentration and then generates the output signals to control/monitor the process. In the case where a natural water source is used in a single pass heat exchanger, where it may contain some level of turbidity (e.g., oil drops) or color, the C4000 can monitor sensors at the inlet and outlet of the exchanger and report a differential measurement. In addition to offering a local display, the C4000 can send relay alarms to even better monitor the process – all in real-time. Options for Profibus PA® or FOUNDATION™ Fieldbus systems are also available.

optek sensors and converters can be installed in any electrical area class, in pressures up to 100 bar and permanent process temperatures of 240 °C (464 °F). The sensors can be installed in line sizes up to 6" and are available in many process connections and material types. optek's ability to customize a system to your exact process conditions offers companies the opportunity to reduce operating costs, improve product quality and minimize process downtime.



optek Stainless Steel Housing with C4000 Converter



optek TF16-EX-HT-N Scattered Light Dual Channel Turbidity Sensor

**Typical Measuring Ranges:**

- 0 - 10 ppm (Oil in Water)
- 0 - 100 APHA/Hazen (Color)
- 0 - 100 mg/l (Aromate UV)

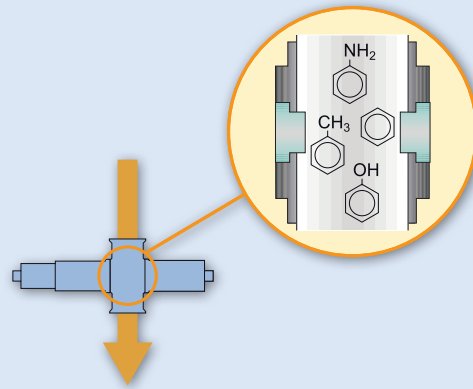

## Boiler Condensate and Carry-over Monitoring

Much like the low pressure sides of heat exchangers, boiler condensate, cooling water and process carryover needs to be monitored to prevent contamination of the plant's boiler system or other manufacturing processes. Continuous inline monitoring enables reusing condensate or reboiler to conserve energy, water and chemical usage.

Similar to heat exchanger monitoring, the contaminating medium requires different sensors to be used to monitor the condensate. Boiler condensate monitoring is a common application where the high temperature version of optek sensors are required, as high pressures can leave the condensate or process stream at well over 100 °C (212 °F).



optek C4000 Photometric Converter



optek AF46-EX-HT  
Dual Channel UV Absorption Sensor



Representantes / Distribuidores Exclusivos

Argentina

Tel: (+54 11) 5352 2500

Email: [info@dastecsrl.com.ar](mailto:info@dastecsrl.com.ar)

Web: [www.dastecsrl.com.ar](http://www.dastecsrl.com.ar)

Uruguay [www.dastecsrl.com.uy](http://www.dastecsrl.com.uy)

Paraguay [www.dastecsrl.com.py](http://www.dastecsrl.com.py)

## 12 | Interface Detection

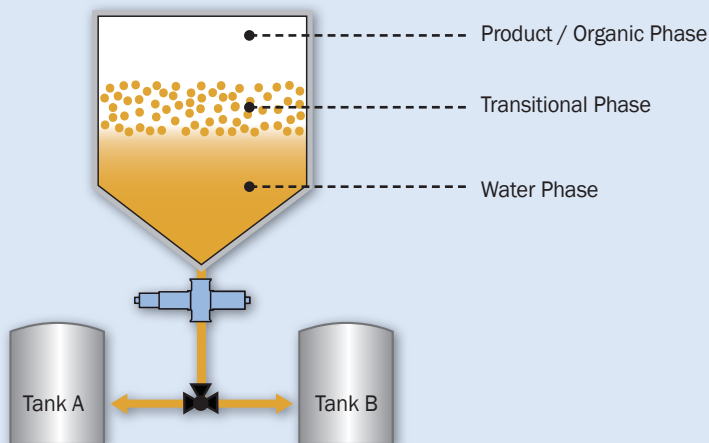

The extraction of high-cost products from an aqueous layer to an organic layer (or vice versa), or salting-in/salting-out processes, are very common and important procedures in the chemical industry.

### Monitor Phase Separations

After settling of the mixture occurs in a batch reactor, the aqueous phase is separated from the organic phase. Depending on process specifics, this can be monitored with an optek AF26 or AF16 absorption sensor at the reactor outlet to ensure separation with high precision.

Each liquid phase shows differences in absorbing light. This technique allows optimization of separation processes and at the same time, minimizes product loss and realizes significant cost savings.

### Automation

optek AF16 or AF26 sensors reduce costs by measuring color or turbidity directly in the process line. There is no need for sight glass monitoring by production personnel, eliminating losses due to manually switching valves and human error.

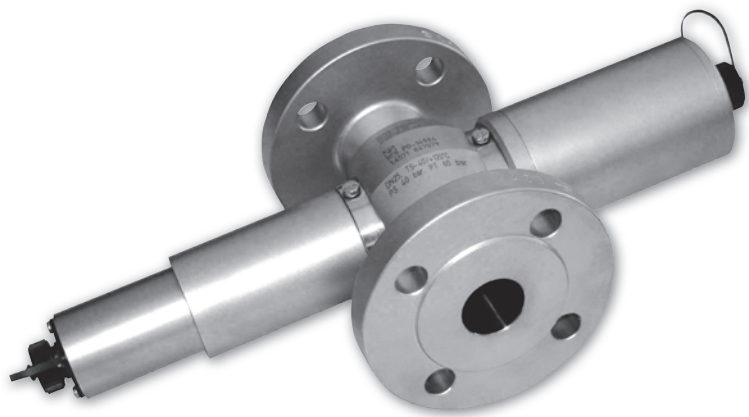

optek AF26 Dual Channel Absorption Sensor



optek C4000 Photometric Converter

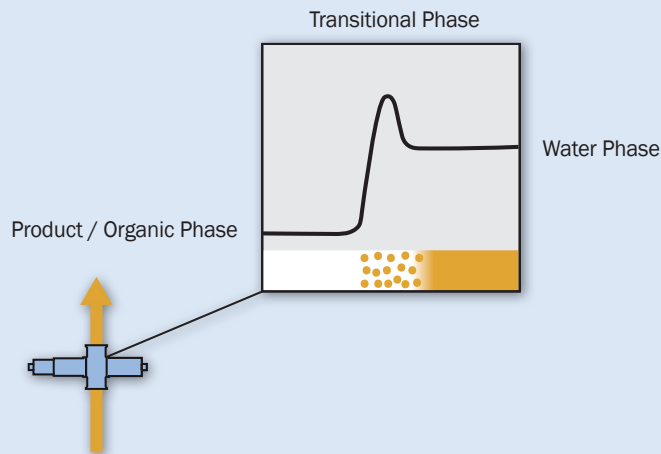

## Increase Product Quality

Product losses are no longer an issue when detecting different phases inline. Faster product changeovers are possible with continuous optek inline measurements. Fast response time and use of relays for automatic diversion ensures product quality and improves process control.

optek manages phase separations in a wide range of wavelengths, from Ultraviolet (UV) to Visible (VIS) and Near Infrared (NIR). This allows optek to customize a solution based on your process media automation requirements and site conditions. Hazardous areas may require the use of our Ex-proof sensors.

The water phase can be detected reliably, ensuring a separation that is independent of the composition of the organic phase.

optek inline sensors detect the most subtle changes in your process so the appropriate action can be made by the control system. Enabling the data logger feature in the C4000 converter allows plants to collect real-time process data for QA/QC. Monitoring phase separations inline and in real-time with optek sensors provides a rapid return on investment.

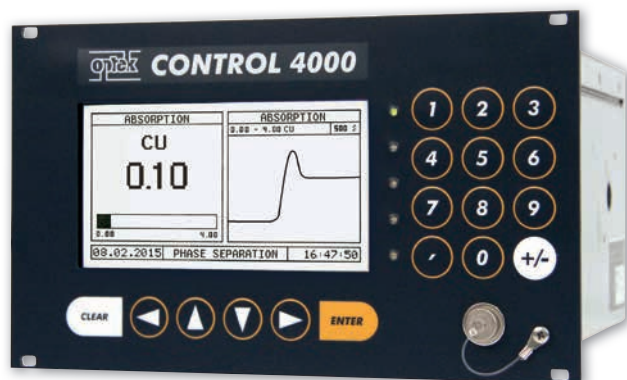

optek C4000 Photometric Converter



optek Calibration Accessories (NIST-traceable)



# 14 | Principles of Measurement

## Sensor AF16

VIS- and NIR-Absorption, single channel concentration and color measurement

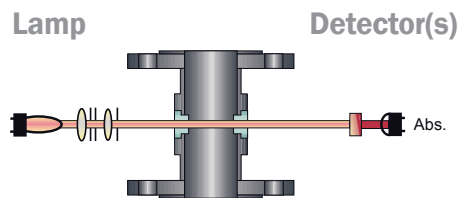

## Sensor AF26

VIS-Absorption, dual channel color measurement with turbidity compensation

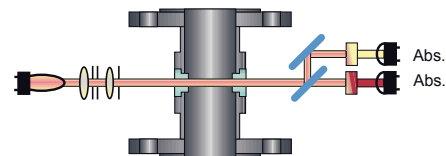

## Sensor AF45

UV-Absorption, single channel concentration measurement with compensation of lamp intensity

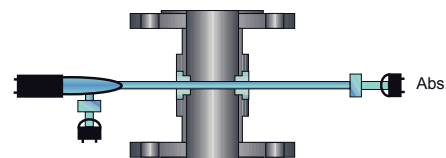

## Sensor AF46

UV-Absorption, dual channel concentration measurement with compensation of lamp intensity

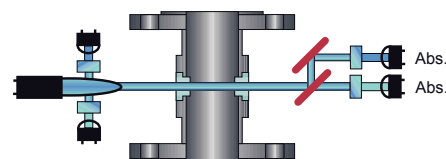

## Sensor TF16

11° Scattered Light and NIR-Absorption, dual channel turbidity measurement

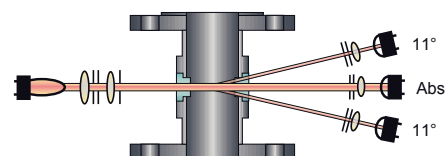

Representantes / Distribuidores Exclusivos

 Argentina

Tel: (+54 11) 5352 2500

Email: [info@dastecsr.com.ar](mailto:info@dastecsr.com.ar)

Web: [www.dastecsr.com.ar](http://www.dastecsr.com.ar)

 Uruguay [www.dastecsr.com.uy](http://www.dastecsr.com.uy)

 Paraguay [www.dastecsr.com.py](http://www.dastecsr.com.py)



## Technical Aspects

Temperatures up to 240 °C (464 °F)

Pressures up to 100 bar (1450 psi)

Line size ¼" to 6"

FM and ATEX approved for hazardous locations

Optical path length (OPL) from 1 to 1000 mm (depending on sensor)

High resistivity materials to withstand the harshest process environments

Reference filter for inprocess "calibration" checks (NIST-traceable)

Universal C4000 converter for all optek sensors (up to four sensors with one converter)

Configurable software allows easy correlation to almost any unit of measure (ppm, %, mg/L, APHA / Hazen / Pt-Co, Saybolt, Gardner®, ASTM, etc.)

PROFIBUS® PA / FOUNDATION™ Fieldbus available

Certification ISO 9001:2015, ATEX, FM, PED, CE, HPO

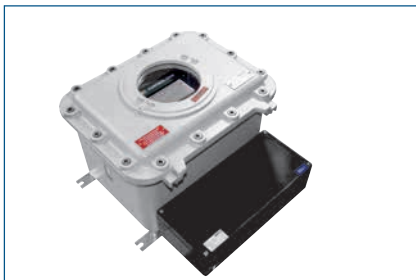

Flameproof Housing Ex d for optek C4000 Converter





 **Germany**  
optek-Danulat GmbH  
Emscherbruchallee 2  
45356 Essen / Germany  
Phone: +49 201 63409 0  
E-Mail: info@optek.de

 **USA**  
optek-Danulat Inc.  
N118 W18748 Bunsen Drive  
Germantown WI 53022 / USA  
Phone: +1 262 437 3600  
Toll free call: +1 800 371 4288  
Fax: +1 262 437 3699  
E-Mail: info@optek.com

 **Singapore**  
optek-Danulat Pte. Ltd.  
25 Int'l Business Park  
#02-09 German Centre  
Singapore 609916  
Phone: +65 6562 8292  
Fax: +65 6562 8293  
E-Mail: info@optek.com.sg

 **China**  
optek-Danulat Shanghai Co., Ltd.  
Room 718 Building 1  
No.88 Keyuan Road  
Pudong Zhangjiang  
Shanghai, China 201203  
Phone: +86 21 2898 6326  
Fax: +86 21 2898 6325  
E-Mail: info@optek-danulat.com.cn

**中国**  
优培德在线测量设备（上海）  
有限公司  
上海张江科苑路88  
号德国中心718  
室 邮编:201203  
电话:+86-21-28986326  
传真:+86-21-28986325  
E-Mail: info@optek-danulat.com.cn



Representantes / Distribuidores Exclusivos

 Argentina

Tel: (+54 11) 5352 2500  
Email: info@dastecsrl.com.ar  
Web: [www.dastecsrl.com.ar](http://www.dastecsrl.com.ar)

 Uruguay [www.dastecsrl.com.uy](http://www.dastecsrl.com.uy)

 Paraguay [www.dastecsrl.com.py](http://www.dastecsrl.com.py)

Please visit our website for contact details of our local distributors in other countries.  
[www.optek.com](http://www.optek.com)